

# ***TIMING LIGHT INSTRUCTIONS***



***CP7527 INDUCTIVE  
CP7528 ADVANCE  
CP7529 DIGITAL***

 **actron**<sup>®</sup>  
precision electronic solutions

Actron, is a Business Unit of SPX Corporation.

# TABLE OF CONTENTS

<b>SAFETY PRECAUTIONS .....</b>	<b>2</b>
<b>TIMING LIGHTS .....</b>	<b>5</b>
<b>HOOKUP PROCEDURE .....</b>	<b>7</b>
<b>MEASURING ENGINE RPM .....</b>	<b>10</b>
<b>MEASURING INITIAL TIMING .....</b>	<b>11</b>
<b>SETTING INITIAL TIMING .....</b>	<b>13</b>
<b>CHECKING &amp; MEASURING CENTRIFUGAL ADVANCE .....</b>	<b>15</b>
<b>MEASURING VACUUM ADVANCE .....</b>	<b>19</b>
<b>DISCONNECTING TIMING LIGHT .....</b>	<b>22</b>
<b>TROUBLESHOOTING AND CARE .....</b>	<b>23</b>
<b>FRANCAIS INSTRUCTIONS .....</b>	<b>26</b>
<b>ESPAÑOL INSTRUCCIONES .....</b>	<b>54</b>

# SAFETY PRECAUTIONS

For safety reasons, read this manual thoroughly before operating Timing Light. Always refer to and follow safety messages and test procedures provided by manufacturer of vehicle or equipment being tested.

The safety messages presented below and throughout this manual are reminders to operator to exercise extreme care when using this test instrument.

**WARNING** Indicates a potentially hazardous situation which, if not avoided, could result in serious injury or death.

**IMPORTANT** Indicates a situation which, if not avoided, may result in damage to the test equipment or vehicle.

## SAFETY EQUIPMENT

### Fire Extinguisher

- For gasoline/chemical / electrical fires

### Safety Goggles

- Protect eyes from Battery Acid / Gasoline / Flying Debris

### Protective Gloves

- Protect Hands from Battery Acid / Hot Exhaust / Engine Parts / Flying Debris

# **SAFETY INSTRUCTIONS**

## **Ventilation**

- Operate vehicle in ventilated area.

## **Moving Parts**

- Remove Jewelry
- Do Not Wear Loose Clothing
- Tie Up Long Hair
- Keep Hands Away From Moving Parts

## **Set Brake**

- Place Car In:
  - Park (For Automatic)
  - Neutral (For Manual)
- Set Parking Brake
- Disable Automatic Parking Brake Release

## **Smoking and Open Flames**

- Never smoke while working on car
- Keep sparks, and open flames away from vehicle
- Do not use fuel injector cleaning solvents when performing diagnostic tests

## **Hot Surfaces**

- Avoid Contact With:
  - Exhaust Manifolds
  - Pipes
  - Radiator
  - Mufflers (catalytic converters)

## **Battery**

- Do Not Lay Tools on Battery
- Do Not Touch Battery Acid
- Do Not Create Short Between Terminals
- If using an auxiliary battery:
  - Connect Jumper Wire Between Negative Terminal on Auxiliary Battery and Ground on Vehicle
  - Place Battery at least 18 inches Above Floor

## **High Voltage**

- 30,000 to 50,000 Volts Present At:
  - Ignition Coil
  - Distributor Cap
  - Ignition Wires
  - Spark Plugs
- Use Insulated Pliers
- Do Not Use Timing Light if Cords are Damaged

# TIMING LIGHTS

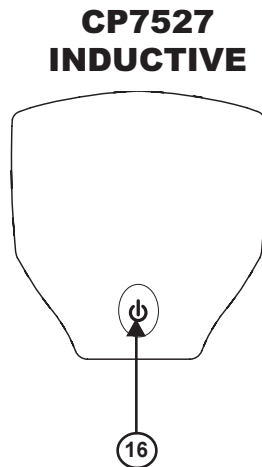
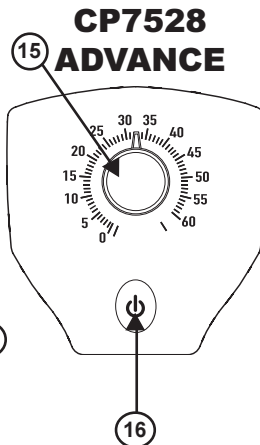
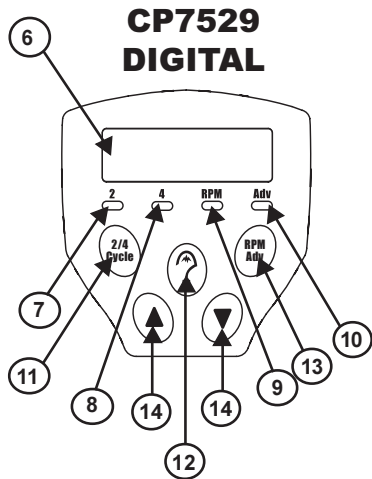

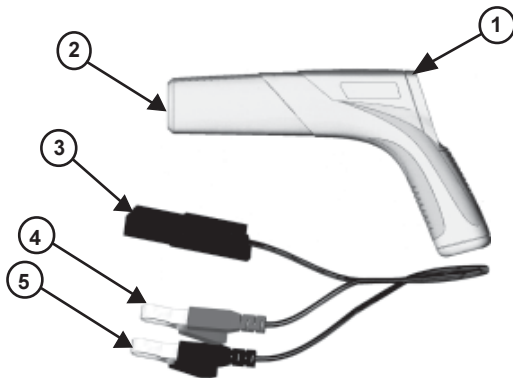

---

**1. Timing Light**

**2. Lens**

**3. Inductive Pickup Clamp**

**4. RED Clip**

**5. BLACK Clip**

**6. 4-digit LED Display**

**7. 2 Cycle Mode Indicator**

**8. 4 Cycle Mode Indicator**

**9. RPM Mode Indicator**

**10. Advance Mode Indicator**

**11. 2/4 Cycle Mode Button**

**12. Flashlight Button**

**13. RPM/Adv Mode Button**

**14. Increase and Decrease  
Advance Buttons**

**15. Advance Knob**

**16. ON Button**

# HOOKUP PROCEDURE

## 1. Turn Vehicle OFF.

**WARNING** Connecting cables with engine running could result in serious injury.

## 2. At distributor, disconnect and plug vacuum line.

## 3. Attach Inductive Pickup Clamp

- Refer to vehicle service manual.
- Clamp on #1 spark plug wire.

**IMPORTANT** Do not allow inductive pickup to touch hot exhaust manifold or surrounding parts.

Close the inductive pickup jaws slowly to prevent damage.

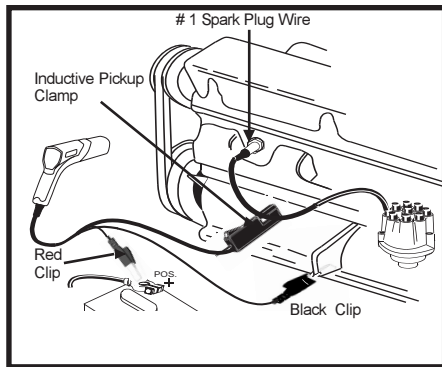

Connect Inductive Pickup Clamp, Red Clip and Black Clip



#### 4. Connect RED and BLACK Battery Clips on Negative Ground Electrical Systems.

- Connect RED to positive (+) battery post.
- Connect BLACK to engine ground.

**IMPORTANT** On 6-volt electrical systems, use an auxiliary 12-volt battery to power timing light. Connect BLACK clip to negative (-) post and RED clip to positive (+) post on auxiliary 12- volt battery. Use 18 AWG or larger wire to connect 12-volt battery negative (-) terminal to a good engine ground.

On 12-volt Positive Ground electrical systems, connect BLACK clip to negative (-) battery post and RED clip to engine ground. DO NOT USE the positive battery post.

On engines equipped with a breaker point ignition system, it will be necessary to set the point dwell before adjusting the timing. Always follow the manufacturer's specifications and test procedures for adjusting dwell angle and idle speed.

## 5. Locate the Timing Marks on the Engine

- The Digital Timing Light is equipped with a flashlight feature. Press and hold the



button for continuous lighting.

## 6. Set 2/4 CYCLE OPERATION (Digital Timing Light Only)

- Use 2-cycle mode on 2-cycle engines and on vehicles equipped with waste-spark distributorless ignition systems (DIS).

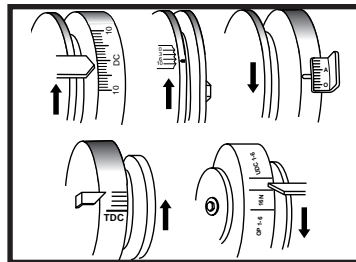

**IMPORTANT** When connected to the battery, the timing light defaults to the 4-cycle, tachometer mode.

- Press and release  button until correct indicator lights.

# MEASURING ENGINE RPM (Digital Timing Light Only)

1. Press and Release  Button Until RPM Indicator Lights.

**IMPORTANT** If engine is not running or #1 spark plug is not firing, timing light display will flash, indicating that no signal is being received.

**Always follow test procedures in vehicle service manual or Vehicle Emission Control Information Label. Instructions given here are for reference only.**

# MEASURING INITIAL TIMING

1. Follow preparation list for checking timing in vehicle service manual.
2. Start engine and warm to operating temperature.
3. Aim timing light at crankshaft damper (pulley) or at transmission bell housing, depending on location of timing marks.

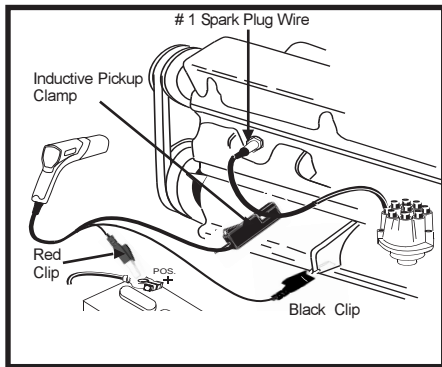

## INDUCTIVE TIMING LIGHT

1. Press and hold down  button.
2. Write down initial timing by counting the timing marks on the engine.

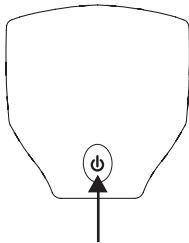

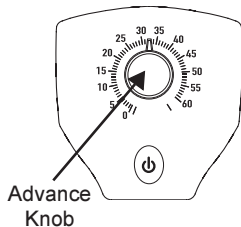

## ADVANCE TIMING LIGHT

1. Press and hold down  button.
2. View timing marks. Turn advance knob until moving mark is aligned with stationary “0” degree timing mark (Top Dead Center).
3. Write down initial timing from dial on timing light.



## DIGITAL TIMING LIGHT

**IMPORTANT** When connected to the battery, the timing light defaults to the 4-cycle, tachometer mode.

1. Press and release  button until ADV indicator lights.
2. View timing marks. Push  and  buttons until moving mark is aligned with stationary “0” degree mark.
3. Write down initial timing from timing light display.

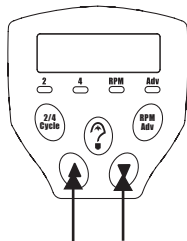

# SETTING INITIAL TIMING

## INDUCTIVE TIMING LIGHT

1. Press and hold down  button.
2. Loosen distributor hold down bolt and turn distributor as necessary until moving mark is aligned with correct stationary timing mark.
3. Tighten distributor hold down bolt securely.

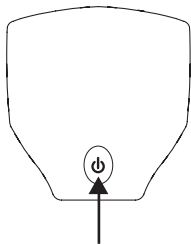

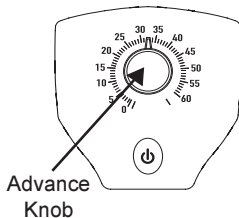

## ADVANCE TIMING LIGHT

1. Turn advance knob to desired degrees advance setting.
2. Press and hold down  button.



3. **View timing marks. Loosen distributor hold down bolt and turn distributor until moving mark is aligned with stationary “0” degree mark.**
4. **Tighten distributor hold down bolt securely.**

## DIGITAL TIMING LIGHT

1. Push  and  buttons until display shows desired degrees advance setting.
2. **View timing marks. Loosen distributor hold down bolt and turn distributor until moving mark is aligned with stationary “0” degree mark.**
3. **Tighten distributor hold down bolt securely.**

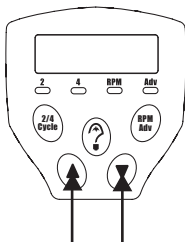

# CHECKING & MEASURING CENTRIFUGAL ADVANCE

## INDUCTIVE TIMING LIGHT

1. Leave distributor vacuum line disconnected and plugged.
2. Press and hold down  button. Note position of timing mark at idle speed.
3. Slowly increase engine speed to 2500 RPM, or other speed specified by manufacturer. Timing mark should move smoothly in opposite direction of engine rotation. Note degrees advance at higher RPM.
4. Subtract degrees advance at idle from degrees at higher speed. Difference is amount of centrifugal advance.
5. Slowly decrease engine speed to idle RPM. Timing mark should move smoothly in direction of engine rotation, and return to idle position.

### NOTES

ADVANCE READING (RPM NOTED  
IN SERVICE MANUAL OR VECI)

— TIMING AT IDLE  
—  
CENTRIFUGAL ADVANCE



# ADVANCE TIMING LIGHT

1. At distributor, leave vacuum line disconnected and plugged.
2. Press and hold down  button. View timing marks. Turn advance knob until moving mark is aligned with stationary “0” degree mark. Note degrees advance at idle speed.
3. Slowly increase engine speed to 2500 RPM, or other speed specified by manufacturer. Timing mark should move smoothly in opposite direction of engine rotation.
4. Turn advance knob until moving mark is aligned with stationary “0” degree mark.
5. Subtract degrees advance at idle from degrees at higher speed. Difference is amount of centrifugal advance.
6. Slowly decrease engine speed to idle RPM. Timing mark should move smoothly in direction of engine rotation.





## NOTES

ADVANCE READING (RPM NOTED  
IN SERVICE MANUAL OR VECI)

— TIMING AT IDLE

CENTRIFUGAL ADVANCE

# DIGITAL TIMING LIGHT

1. At distributor, leave vacuum line disconnected and plugged.
2. Push  and  buttons until moving mark is aligned with the stationary “0” degree mark. On display, note degrees advance at idle.
3. Slowly increase engine speed to 2500 RPM, or other speed specified by manufacturer. Timing mark should move smoothly in opposite direction of engine rotation.
4. Push  and  buttons until moving mark is aligned with stationary “0” degree mark.
5. Subtract degrees advance at idle from degrees at higher speed. Difference is amount of centrifugal advance.
6. Slowly decrease engine speed to idle RPM. Timing mark should move smoothly in direction of engine rotation.

## NOTES

ADVANCE READING (RPM NOTED  
IN SERVICE MANUAL OR VECI)

— TIMING AT IDLE  
CENTRIFUGAL ADVANCE

**LEFT BLANK ON PURPOSE**

# MEASURING VACUUM ADVANCE

Checking the vacuum advance mechanism requires a vacuum pump with gauge in addition to the timing light.

## INDUCTIVE TIMING LIGHT

- 1. Leave distributor vacuum line disconnected and plugged. Connect vacuum pump to distributor.**
- 2. Increase engine speed to RPM specified by vehicle manufacturer.**
- 3. Press and hold down  button. Note advance at specified RPM.**
- 4. Use pump to apply vacuum specified by manufacturer. Note degrees advance with vacuum applied.**
- 5. Subtract degrees advance without vacuum from degrees with vacuum applied. Difference is amount of vacuum advance.**
- 6. Remove vacuum from distributor and return engine speed to idle.**

### NOTES

RPM XXXX  
VACUUM XXXXX  
ADV. RPM XX  
VACUUM XX

ADVANCE WITH VACUUM  
- ADVANCE WITHOUT VACUUM  
Contribution of Vacuum

# ADVANCE TIMING LIGHT

1. At distributor, leave vacuum line disconnected and plugged. Connect vacuum pump to distributor.
2. Increase engine speed to RPM specified by vehicle manufacturer.
3. Use pump to apply vacuum specified by manufacturer.
4. Press and hold down  button. Turn advance knob until moving mark is aligned with stationary “0” degree mark. Note advance at specified RPM.
5. Subtract degrees advance without vacuum from degrees with vacuum applied. Difference is amount of vacuum advance.
6. Remove vacuum from distributor and return engine speed to idle.

## NOTES

RPM XXXX  
VACUUM XXXXX  
ADV. RPM XX  
VACUUM XX

ADVANCE WITH VACUUM  
- ADVANCE WITHOUT VACUUM  
Contribution of Vacuum

## DIGITAL TIMING LIGHT

1. At distributor, leave vacuum line disconnected and plugged. Connect vacuum pump to distributor.
2. Increase engine speed to RPM specified by vehicle manufacturer.

Push  and  buttons until moving mark is aligned with stationary “0” degree mark. Note advance at specified RPM.

3. Use pump to apply vacuum specified by manufacturer.

4. Push  and  buttons until moving mark is aligned with stationary “0” degree mark. Note degrees advance with vacuum applied.

5. Subtract degrees advance without vacuum from degrees with vacuum applied. Difference is amount of vacuum advance.
6. Remove vacuum from distributor and return engine speed to idle.

### NOTES

RPM XXXX  
VACUUM XXXXX  
ADV. RPM XX  
VACUUM XX

ADVANCE WITH VACUUM  
- ADVANCE WITHOUT VACUUM  
Contribution of Vacuum

# DISCONNECTING TIMING LIGHT

1. Turn Vehicle OFF.

**▲WARNING** Disconnecting cables with vehicle engine running could result in serious injury.

2. At distributor, unplug and reconnect vacuum line.
3. Remove Inductive Pickup Clamp.
4. Disconnect RED and BLACK Battery Clips.

# TROUBLESHOOTING AND CARE

## Timing Light Flashes Randomly

### 1. Clean Inductive Pickup Clamp Inside Surfaces with Soft Cloth

**IMPORTANT** Do not allow tool to touch exhaust manifold or surrounding parts due to extreme heat.

Do not drop pickup or snap it shut. Always close jaws slowly to prevent damage.

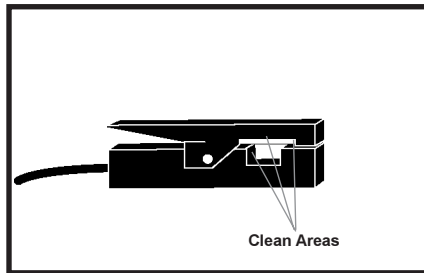



**2. Slide Inductive Pickup Clamp**

- To new spot on #1 spark plug wire

**3. Turn Inductive Pickup Over**

- To opposite direction on #1 spark plug wire

**4. Replace Spark Plug Wire**

- If solid copper spark plug wires are used replace #1 spark plug wire with a resistive type wire.
- Reinstall original spark plug wire after completing test.

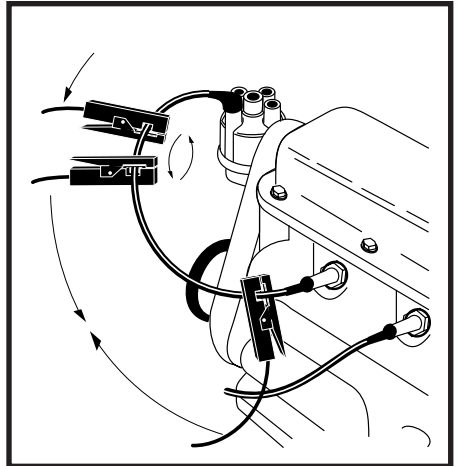

## **FULL ONE (1) YEAR WARRANTY**

SPX Corporation, 15825 Industrial Parkway, Cleveland, Ohio 44135, warrants to the user that this unit will be free from defects in materials and workmanship for a period of one (1) year from the date of original purchase.

Any unit that fails within this period will be repaired or replaced at SPX Corporation's option and without charge when returned to the Factory. SPX Corporation requests that a copy of the original, dated sales receipt be returned with the unit to determine if the warranty period is still in effect.

This warranty does not apply to damages caused by accident, alterations, or improper or unreasonable use. Expendable items, such as fuses, lamp bulbs, flash tubes are also excluded from this warranty.

**SPX CORPORATION DISCLAIMS ANY LIABILITY FOR INCIDENTAL OR CONSEQUENTIAL DAMAGES FOR BREACH OF ANY WRITTEN WARRANTY ON THE UNIT.**

Some states do not allow the disclaimer of liability for incidental or consequential damages, so the above disclaimer may or may not apply to you. This warranty gives specific legal rights, and you may also have rights which vary from state to state.

If you have any questions about the operations of the product, call (800)228-7667.